

supersonic nural

User manual

Supersonic nural

Back view of the Dyson Supersonic Nural hair dryer



HD16 JN.00000 PN.000000-00-00
00.00.00 VERSION NO.01

Contents

In the box

Getting started

Nural™ sensors

Capsule illumination

Styling attachments

LEDs

Regular filter cleaning

In the box



Dyson Supersonic Nural™ hair dryer

Back view of the Dyson Supersonic Nural™ hair dryer. Starting at the head of the machine, the Scalp protect button is at the top, airflow button on the left, and temperature button on the right. The handle has power and Cold shot buttons at the top, and the filter cage at the bottom.



Gentle air attachment

Flat nozzle with a rippled texture.



Styling concentrator

Flattened, flared nozzle.

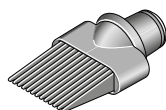

Wide-tooth comb

Comb attachment with long, widely-spaced tines.

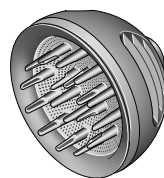

Wave+ Curl diffuser

Domed attachment with removable prong bed.



Flyaway attachment

Flat, curved nozzle.

Getting started

View of the back of the Dyson Supersonic Nural hair dryer showing the airflow button with LED lights on the left, the temperature button with LEDs on the right, and the Scalp protect button at the top. The power button and cold shot buttons are below, on the handle.

Scalp protect mode on/off

Scalp care is activated by default on first use.

The Scalp protect button is on the back, at the top of the cylindrical head of the hair dryer.

Capsule

Home to the Time of Flight sensor, Hall sensor and Capsule illumination.

The capsule is suspended in the middle of the hair dryer's central bore.

Airflow control

3 precise settings:
- Fast/High
- Gentle/Medium
- Mild/Low

The airflow control button is on the back left-hand side of the cylindrical head of the hair dryer.

Power on/off

Sliding switch.

The power button is on the back, at the top of the handle. It is a slider button that pushes upwards or downwards.

Cold shot

Press and hold to deactivate heat and set style.

The Cold shot button is on the back of the handle of the hair dryer, just below the power button.

Air inlet

The air inlet is covered by the filter and is at the bottom of the handle.

LEDs

The LED lights are on the back of the cylindrical head of the hair dryer. They are above the airflow and temperature buttons. There are three LED lights on each side, which light up as the corresponding button is pressed. These lights also indicate when your filter needs cleaning or if there is a fault.

Temperature control

4 precise heat settings.
The temperature control button is on the back right-hand side of the cylindrical head of the hair dryer.

Removable filter cage

Easy to remove for cleaning.
The filter cage is at the bottom of the handle.

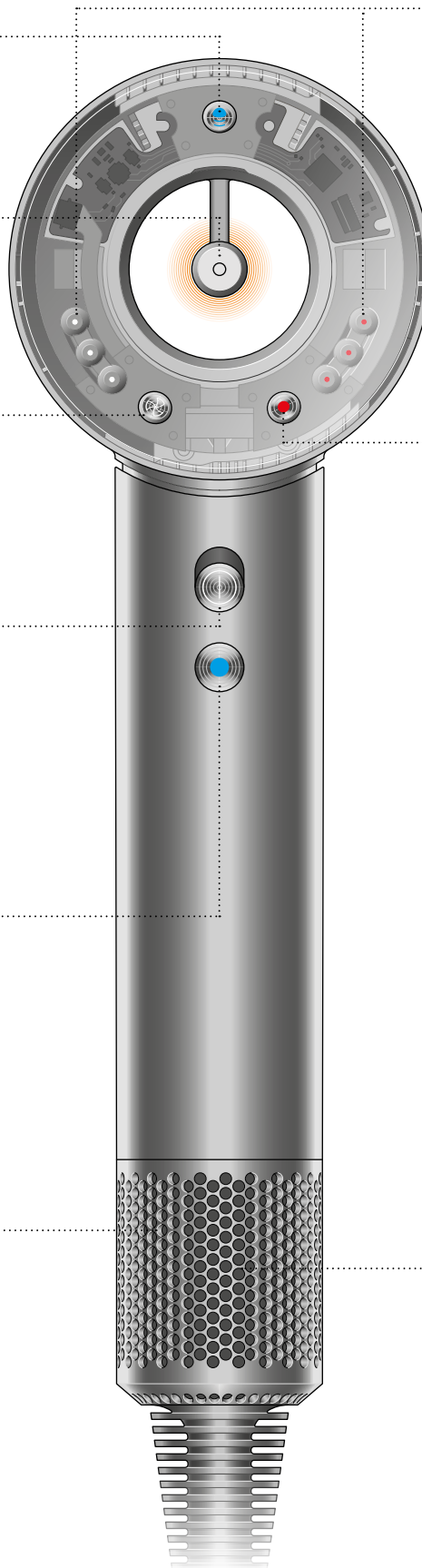

Nural™ sensors

A network of Nural™ sensors helps the Dyson Supersonic Nural hair dryer enhance and optimise your hair care routine.

Scalp protect mode

A Time of Flight sensor measures distance, automatically reducing heat as it moves closer to your hair. To maintain a comfortable, consistent scalp temperature.

Two images of a woman using the Dyson Supersonic Nural hair dryer. On the left, the hair dryer is in Medium heat setting. On the right, the dryer is closer to the hair and Scalp protect mode has automatically adapted to Low heat setting.

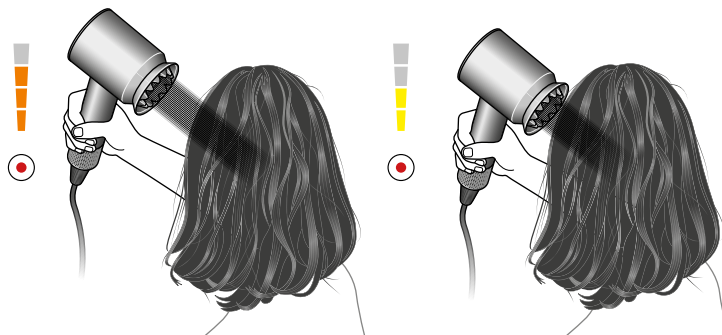

Pause detect

A motion-sensing accelerometer knows when it's put down, automatically deactivating the heater, and decreasing airflow and noise. Capsule illumination will pulse blue.

Tip: To be sure Pause detect has activated, wait for the motor sound to ramp down before lifting your hand off the hair dryer. Capsule illumination will pulse blue.

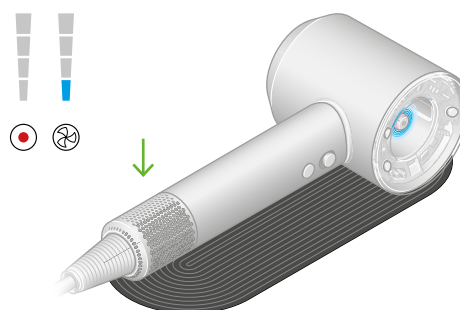

The Dyson Supersonic Nural hair dryer laying flat with Pause detect mode activated. Heat is off, airflow is minimal, and Capsule illumination is blue.

Attachment learning

A Hall sensor recognises which styling attachment is connected, automatically switching to its last-used settings.

Capsule illumination

The suspended capsule changes colour to show the current heat setting. Heat, and colour, will auto-adapt in Scalp protect mode.

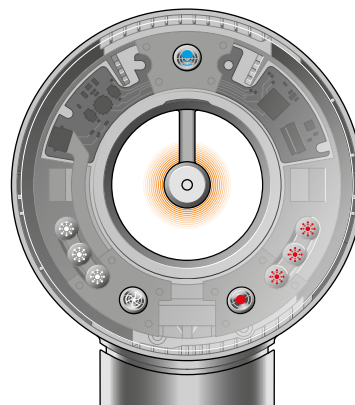





- High heat
- Medium heat
- Low heat
- No heat

The capsule is suspended in the central bore of the hair dryer. LED lights in the capsule glow red to indicate high heat, orange for medium heat, yellow for low heat, and blue for no heat.

Styling attachments

Attachment learning recognises your Intelligent attachments and learns your go-to styling preferences for each.

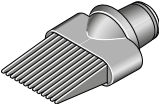
All attachments are magnetic, for easy rotation and fitting. Heat Shield technology keeps the surface of your styling attachments cool. Remove your attachments using the cool edges.

	Styling attachment	Heat and airflow presets	Works with Scalp protect mode	Works with Pause detect
	Gentle air attachment Evenly diffuses airflow for gentle yet fast drying.	High heat High flow ¹	Yes	Yes
	Styling concentrator Wider and thinner, for precision styling.	High heat Medium flow	Yes	Yes
	Wide-tooth comb Helps stretch and lengthen hair.	High heat High flow		Yes
	Wave+ Curl diffuser Disperses airflow in two different ways.	Medium heat Medium flow		
	Flyaway attachment Coanda airflow to hide flyaways. ²	Low heat High flow		Yes

1. Gentle air attachment follows the same default presets as the hair dryer with no attachment connected. 2. For use on dry and straight[ened] hair.

LEDs

Settings

The LED lights indicate which settings you are using.

Airflow

Three white LEDs illuminated.

Two white LEDs illuminated.

One white LED illuminated.

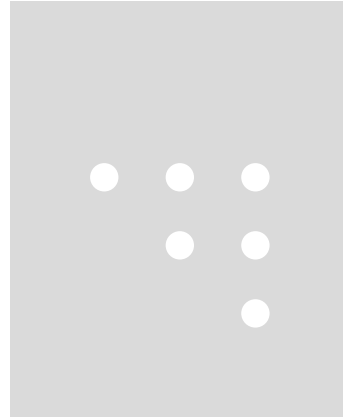

Fast/High

Gentle/Medium

Mild/Low

Temperature

Maximum operating temperature in normal working conditions: 105°C.

Maximum thermistor temperature at safety shut down: 145°C.

Three red LEDs illuminated.

Two red LEDs illuminated.

One red LED illuminated.

No red LED illuminated.

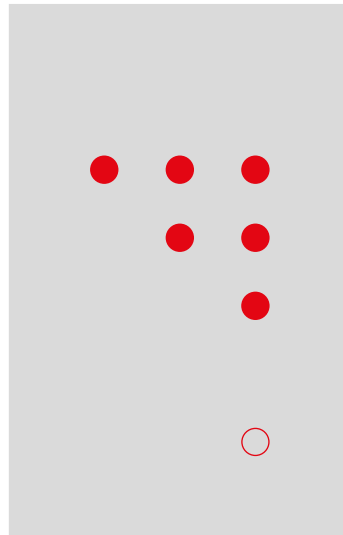

High

Medium

Low

Cool

Diagnostics

The LEDs will flash continuously to let you know that your machine needs attention.

Clean the filter. Follow the instructions or watch the video at [dyson.com/yoursupersonicnural](https://www.dyson.com/yoursupersonicnural).

If all three red lights continue to flash, contact the Dyson Helpline.

Don't turn back on.

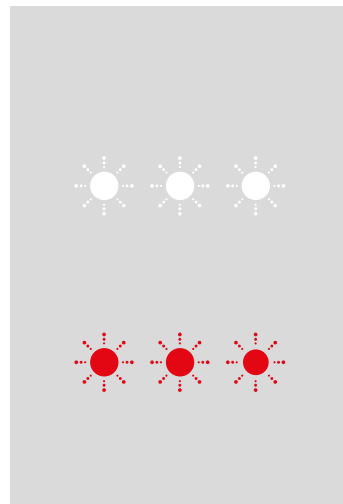

Three flashing white LEDs.

Three flashing red LEDs.

Regular filter cleaning

Check your filter is clear of debris and hair product residue every month, or when the LED lights alert you.

Maintaining performance

Unplug your machine from the mains electricity supply and allow it to cool down before cleaning your filter.

The Dyson Supersonic Nural™ hair dryer has highly tuned technology to give outstanding performance.

This technology needs to be kept free from debris and hair product residue. Regular maintenance is required to maintain performance.

Step 1

Hold the handle of your machine firmly and gently rotate the filter cage anti-clockwise.

Step 2

Pull down and away from the machine. Use a lint-free cloth or soft brush to remove any dust or debris from both the filter cage and the filter mesh.

Step 3

Do not use water to clean the filter mesh and avoid applying too much pressure.

Step 4

Rotate the filter cage back into position until correctly aligned. Rotate clockwise to lock before use.

Close-up of the filter cage removed from the filter. A cloth gently cleans the filter and the cage.

Close-up of the removable filter cage at the bottom of the hair dryer. Arrows indicate twisting to the left and pulling away.

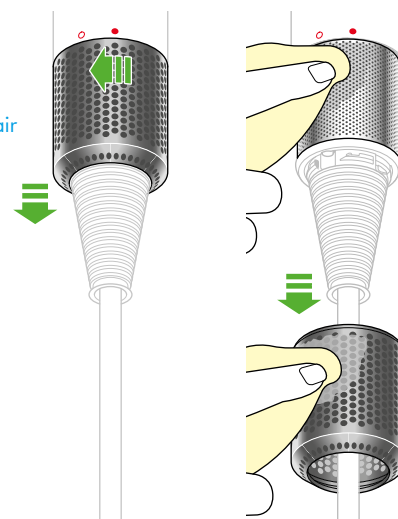

Close-up of the removable filter cage at the bottom of the hair dryer. An arrow indicates twisting to the right to re-secure.

